

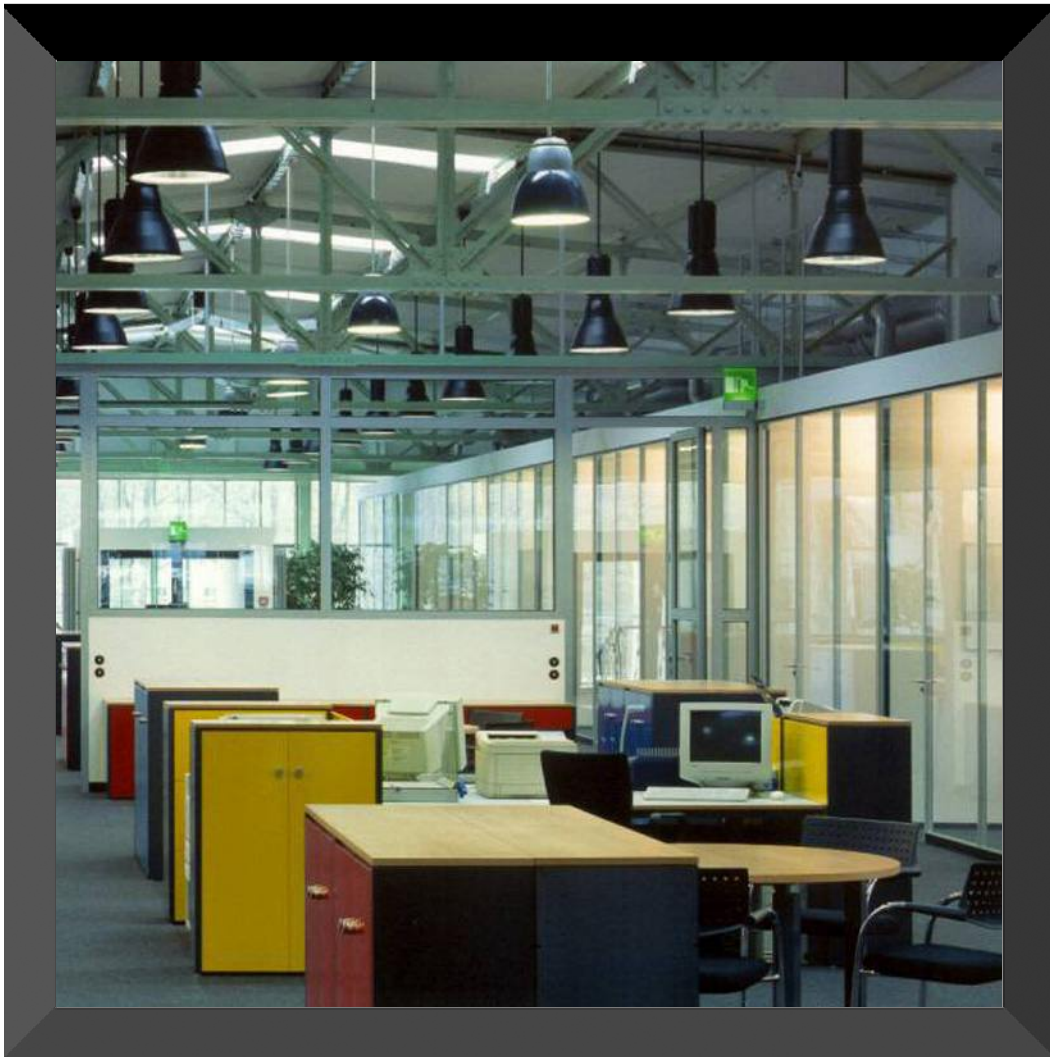

BLESS
ART

Raumsysteme

Möbelsystem





Möbelsystem Modulsystem

BLESS ART

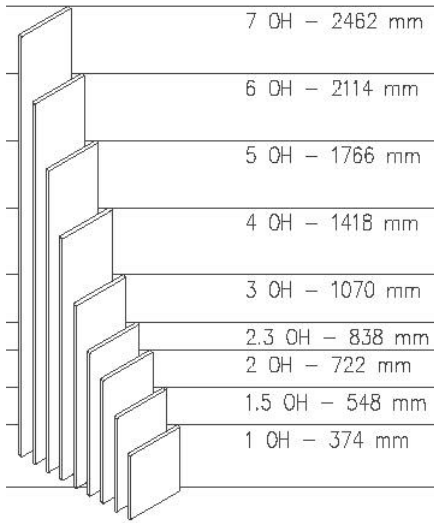

Seitenteile :
8 Höhen + 2 Breiten
Modulmass Tiefe 238 mm

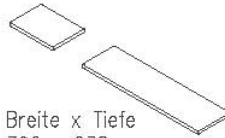

Breite x Tiefe
390 x 238 mm
780 x 238 mm

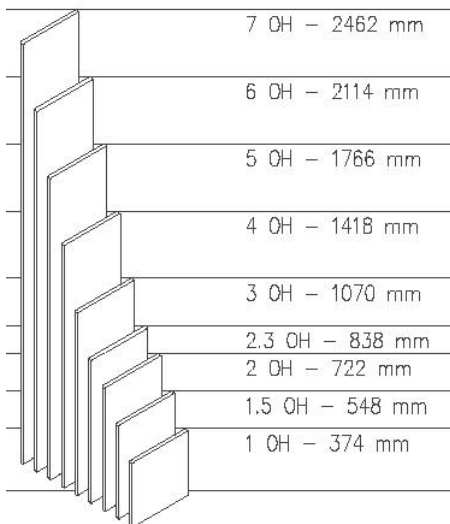

Seitenteile :
8 Höhen + 2 Breiten
Modulmass Tiefe 382 mm

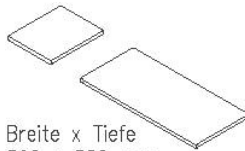

Breite x Tiefe
390 x 382 mm
780 x 382 mm

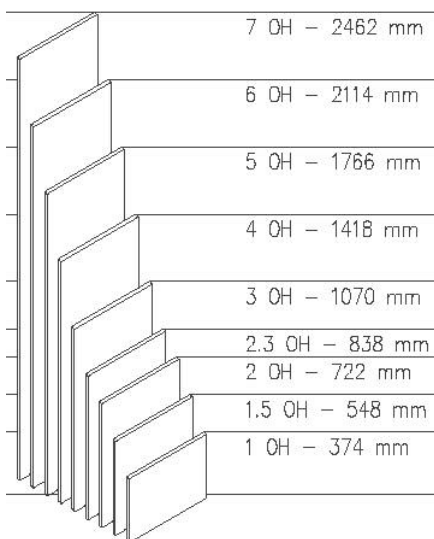

Seitenteile :
8 Höhen + 2 Breiten
Modulmass Tiefe 526 mm

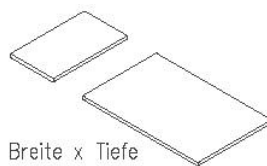

Breite x Tiefe
390 x 526 mm
780 x 526 mm





Möbelsystem Grundelemente

BLESS ART

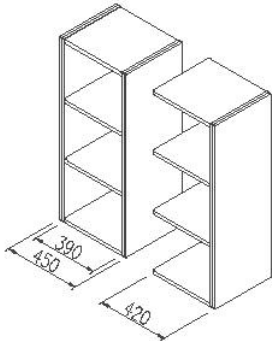

Regal
Grund- und Anbauelement
3 Tiefen
Modulmass Breite 420 mm
Grundelement Breite 450 mm

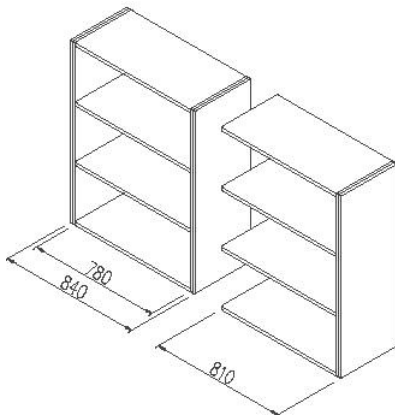

Regal
Grund- und Anbauelement
3 Tiefen
Modulmass Breite 810 mm
Grundelement Breite 840 mm

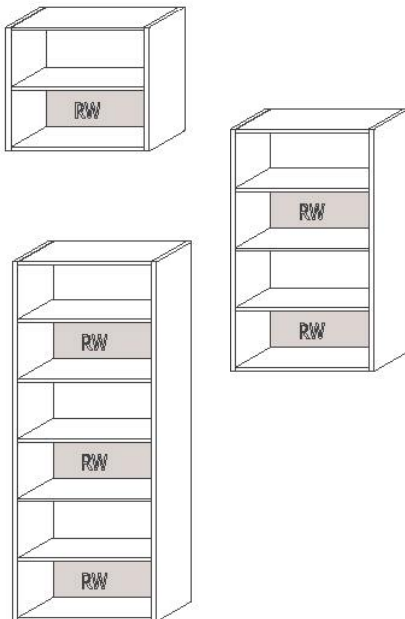

Rückwand Modulmass
Höhe 348 1 OH
Höhe 174 0.5 OH
Höhe 116 0.3 OH

Anzahl Rückwände
(Minimum für Stabilität)
Höhe 1 – 3 OH 1 Rückwände
Höhe 4 – 5 OH 2 Rückwände
Höhe 6 – 7 OH 3 Rückwände





Möbelsystem

Fronten

Türen, Klappen, Rolladen

BLESS
ART

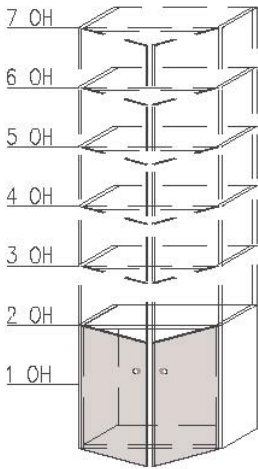

Türflügel
passend auf Systemhöhe OH 1-7
Systembreite 390 mm = 1-flügelig
Systembreite 780 mm = 2-flügelig



Scharniere 180° öffnend,
mit Schliessautomatik
Schubladen können auch hinter
der Türe eingebaut werden.

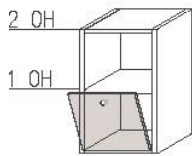

Klappe
Mit selbstschliessendem
Scharnier
H = 1 OH, 348 mm
Systembreite 390 mm

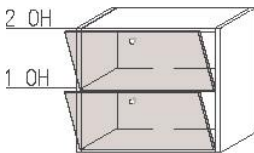

Klappe
Mit selbstschliessendem
Scharnier
H = 1 OH, 348 mm
Systembreite 780 mm

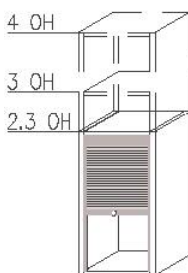

Rolladen Kunststoff
Standard 2.3 OH
Variante 3 + 4 OH
Systembreite 390 mm

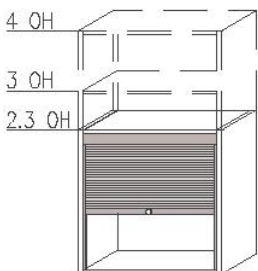

Rolladen Kunststoff
Standard 2.3 OH
Variante 3 + 4 OH
Systembreite 780 mm





Möbelsystem

Regal Abschlüsse

Schubladen + Einsätze

BLESS ART

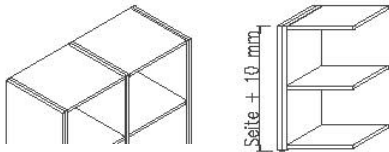

Regal – Abschluss oben
Standard mit Tablar

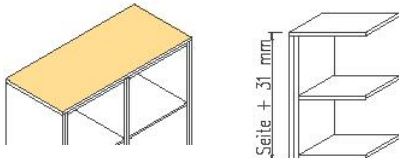

Regal – Abschluss oben
Variante Holztop

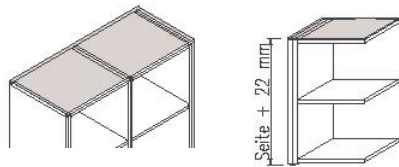

Regal – Abschluss oben
Variante Glastop



Regal – Abschluss unten
Standard mit Fusschrauben



Regal – Abschluss unten
Variante mit Rollen

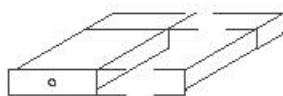

Schubladen - Hängeregistratur
Vollauszug mit 50 kg Tragkraft
Rahmenhöhe 90 mm

Höhe	Breite	Tiefe
116	390 / 780	382
116	390 / 780	526
174	390 / 780	382
174	390 / 780	526
348	390 / 780	382
348	390 / 780	526

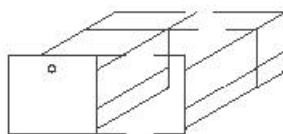
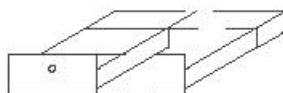

Organisation :

Materialeinsatz, Kleinteileschieber
Formulareinsatz, Karteibahn
CD-Einsatz, Schubladenrahmen
Hängeregistratur





Möbelsystem Tisch System

BLESS ART

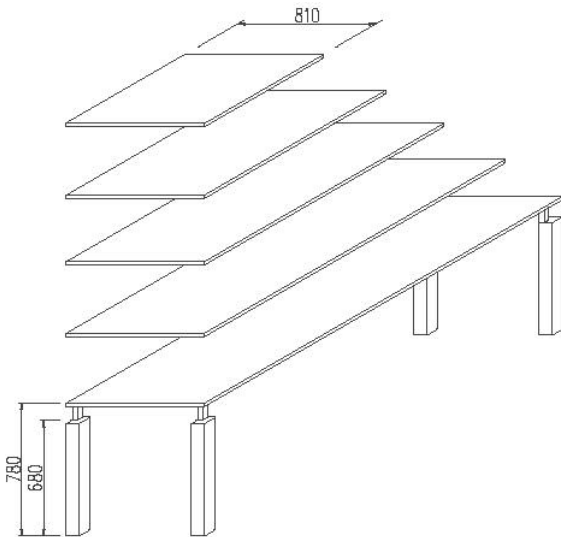

Rechteckiger Tisch
Höhe einstellbar 680 – 780 mm
4 Beine eckig 75 x 75 mm
Stahl pulverbeschichtet
Tischplatten, Span 19 mm
Buche furniert
Melaminbeschichtet hellgrau

Tischgrößen:

810 mm x 810 mm
810 mm x 1230 mm
810 mm x 2040 mm
810 mm x 2430 mm
810 mm x 2850

Runder Tisch \varnothing 1000 mm

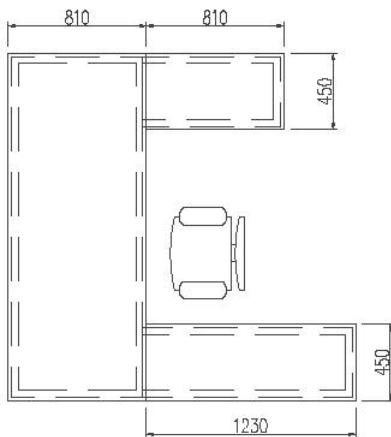

Tisch – Anbauelement
Winkelanbau
450 mm x 810 mm
450 mm x 1230 mm

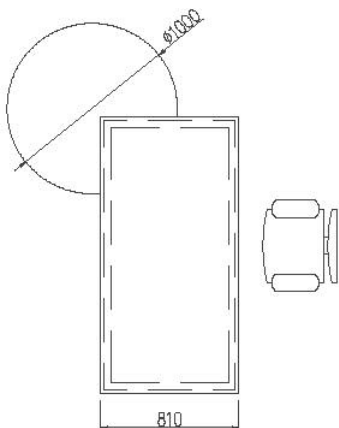

Tisch – Anbauelement
Besprechungsanbau
Rund \varnothing 1000 mm

